



ETA-Danmark A/S  
Göteborg Plads 1  
DK-2150 Nordhavn  
Tel. +45 72 24 59 00  
Fax +45 72 24 59 04  
Internet www.etadanmark.dk

Authorized and notified according  
to Article 29 of the Regulation (EU)  
No 305/2011 of the European  
Parliament and of the Council of 9  
March 2011

MEMBER OF EOTA



## European Technical Assessment ETA-09/0214 of 15/10/2015

### General Part

#### Technical Assessment Body issuing the ETA and designated according to Article 29 of the Regulation (EU) No 305/2011: ETA-Danmark A/S

Trade name of the  
construction product:

Drüeke & Springob Angle Brackets (type 1111, 1112,  
1113, 1131, 1132, 1133)

Product family to which the  
above construction product  
belongs:

Three-dimensional nailing plate (Angle Bracket for  
timber-to-timber connections)

Manufacturer:

Drüeke & Springob GmbH  
Bahnstrasse 19  
57439 Attendorn - Kraghammer  
Tel. +49 02722 - 7771  
Fax +49 02722 – 7922

Manufacturing plant:

Drüeke & Springob GmbH  
Bahnstrasse 19  
57439 Attendorn - Kraghammer

This European Technical  
Assessment contains:

18 pages including 2 annexes which form an integral  
part of the document

This European Technical  
Assessment is issued in  
accordance with Regulation  
(EU) No 305/2011, on the  
basis of:

Guideline for European Technical Approval (ETAG) No.  
015 Three Dimensional Nailing Plates, April 2013, used  
as European Assessment Document (EAD).

This version replaces:

The ETA with the same number issued on 2014-09-02

Translations of this European Technical Assessment in other languages shall fully correspond to the original issued document and should be identified as such.

Communication of this European Technical Assessment, including transmission by electronic means, shall be in full (excepted the confidential Annex(es) referred to above). However, partial reproduction may be made, with the written consent of the issuing Technical Assessment Body. Any partial reproduction has to be identified as such

## II SPECIFIC PART OF THE EUROPEAN TECHNICAL ASSESSMENT

### 1 Technical description of product and intended use

#### Technical description of the product

Drüeke & Springob angle brackets with and without rib are one-piece non-welded, face-fixed angle brackets to be used in timber to timber connections. They are connected to the timber elements by a range of profiled nails.

The angle brackets are made from pre-galvanized steel DX 51 D / Z 275 according to EN 10346:2009 with  $R_e \geq 295 \text{ N/mm}^2$ ,  $R_m \leq 360 \text{ N/mm}^2$  and  $A_{80} \geq 22\%$  and are available with or without an embossed rib. Dimensions, hole positions and typical installations are shown in Annex A. Drüeke & Springob angle brackets are made from steel with tolerances according to EN 10143.

### 2 Specification of the intended use in accordance with the applicable EAD

The angle brackets are intended for use in making connections in load bearing timber structures, as a connection between a beam and a purlin, where requirements for mechanical resistance and stability and safety in use in the sense of the Basic Work Requirements 1 and 4 of the Regulation 305/2011 (EU) shall be fulfilled.

The connection may be with a single angle bracket or with an angle bracket on each side of the fastened timber member (see Annex A).

The static and kinematical behaviour of the timber members or the supports shall be as described in Annex B.

The wood members may be of solid timber, glued laminated timber and similar glued members, or wood-based structural members with a characteristic density from  $290 \text{ kg/m}^3$  to  $420 \text{ kg/m}^3$ . This requirement to the material of the wood members can be fulfilled by using the following materials:

- Structural solid timber classified to C14-C40 according to EN 338 / EN 14081,
- Glulam classified to GL24-GL36 according to EN 1194 / EN 14080,
- LVL according to EN 14374,
- Parallam PSL,
- Intrallam LSL,
- Duo- and Triobalken,
- Layered wood plates,
- Plywood according to EN 636

Annex B states the load-carrying capacities of the angle bracket connections for a characteristic density of  $350 \text{ kg/m}^3$ . For timber or wood based material with a lower characteristic density than  $350 \text{ kg/m}^3$  the load-carrying

capacities shall be reduced by the  $k_{\text{dens}}$  factor:

$$k_{\text{dens}} = \left( \frac{\rho_k}{350} \right)^2$$

Where  $\rho_k$  is the characteristic density of the timber in  $\text{kg/m}^3$ .

The design of the connections shall be in accordance with Eurocode 5 or a similar national Timber Code. The wood members shall have a thickness which is larger than the penetration depth of the nails into the members.

The angle brackets are primarily for use in timber structures subject to the dry, internal conditions defined by service classes 1 and 2 of Eurocode 5 and for connections subject to static or quasi-static loading.

The angle brackets can also be used in outdoor timber structures, service class 3, when a corrosion protection in accordance with Eurocode 5 is applied, or when stainless steel with similar or better characteristic yield and ultimate strength is employed.

The scope of the connectors regarding resistance to corrosion shall be defined according to national provisions that apply at the installation site considering environmental conditions and in conjunction with the admissible service conditions according to EN 1995-1-1 and the admissible corrosivity category as described and defined in EN ISO 12944-2

#### Assumed working life

The assumed intended working life of the angle brackets for the intended use is 50 years, provided that they are subject to appropriate use and maintenance.

The information on the working life should not be regarded as a guarantee provided by the manufacturer or ETA Danmark. An “assumed intended working life” means that it is expected that, when this working life has elapsed, the real working life may be, in normal use conditions, considerably longer without major degradation affecting the essential requirements.

### 3 Performance of the product and references to the methods used for its assessment

Characteristic	Assessment of characteristic
<b>3.1 Mechanical resistance and stability (BWR 1)*</b>	
Characteristic load-carrying capacity	See Annex B
Stiffness	No performance determined
Ductility in cyclic testing	No performance determined
<b>3.2 Safety in case of fire (BWR 2)</b>	
Reaction to fire	The angle brackets are made from steel classified as <b>Euroclass A1</b> in accordance with EN 13501-1:2007+A1:2009 and EC decision 96/603/EC, amended by EC Decision 2000/605/EC
<b>3.3 Hygiene, health and the environment (BWR 3)</b>	
Influence on air quality	The product does not contain/release dangerous substances specified in TR 034, dated March 2012
<b>3.7 Sustainable use of natural resources (BWR 7)</b>	No Performance Determined
<b>3.8 General aspects related to the performance of the product</b>	The angle brackets have been assessed as having satisfactory durability and serviceability when used in timber structures using the timber species described in Eurocode 5 and subject to the conditions defined by service class 1 and 2
Identification	See Annex A

\*) See additional information in section 3.9 – 3.12.

In addition to the specific clauses relating to dangerous substances contained in this European technical Assessment, there may be other requirements applicable to the products falling within its scope (e.g. transposed European legislation and national laws, regulations and administrative provisions). In order to meet the provisions of the Construction Products Regulation, these requirements need also to be complied with, when and where they apply.

### 3.9 Methods of verification

#### Safety principles and partial factors

The characteristic load-carrying capacities are based on the characteristic values of the nail connections and the steel plates. To obtain design values the capacities have to be divided by different partial factors for the material properties, the nail connection in addition multiplied with the coefficient  $k_{mod}$ .

According to EN 1990 (Eurocode – Basis of design) paragraph 6.3.5 the design value of load-carrying capacity may be determined by reducing the characteristic values of the load-carrying capacity with different partial factors.

Thus, the characteristic values of the load-carrying capacity are determined also for timber failure  $F_{Rk,H}$  (obtaining the embedment strength of nails subjected to shear or the withdrawal capacity of the most loaded nail, respectively) as well as for steel plate failure  $F_{Rk,S}$ . The design value of the load-carrying capacity is the smaller value of both load-carrying capacities.

$$F_{Rd} = \min \left\{ \frac{k_{mod} \cdot F_{Rk,H}}{\gamma_{M,H}}; \frac{F_{Rk,S}}{\gamma_{M,S}} \right\}$$

Therefore, for timber failure the load duration class and the service class are included. The different partial factors  $\gamma_M$  for steel or timber, respectively, are also correctly taken into account.

#### 3.10 Mechanical resistance and stability

See annex B for the characteristic load-carrying capacity in the different directions  $F_1$  to  $F_5$ .

The characteristic capacities of the angle brackets are determined by calculation assisted by testing as described in the EOTA Guideline 015 clause 5.1.2. They should be used for designs in accordance with Eurocode 5 or a similar national Timber Code.

*Threaded nails (ringed shank nails) in accordance to EN 14592*

In the formulas in Annex B the capacities for threaded nails calculated from the formulas of Eurocode 5 are used assuming a thick steel plate when calculating the lateral nail load-carrying-capacity.

The load bearing capacities of the brackets has been determined based on the use of connector nails 4,0 x 40 mm in accordance with the German national approval for the nails.

The characteristic withdrawal capacity of the nails has to be determined by calculation in accordance with EN 1995-1-1: 2004, paragraph 8.3.2 (head pull-through is not relevant):

$$F_{ax,Rk} = f_{ax,k} \times d \times t_{pen}$$

Where:

$f_{ax,k}$	Characteristic value of the withdrawal parameter in N/mm <sup>2</sup>
$d$	Nail diameter in mm
$t_{pen}$	Penetration depth of the profiled shank including the nail point in mm, $t_{pen} \geq 31$ mm

Based on tests by Versuchsanstalt für Stahl, Holz und Steine, University of Karlsruhe, the characteristic value of the withdrawal resistance for the threaded nails used can be calculated as:

$$f_{ax,k} = 50 \times 10^{-6} \times \sigma_k^2$$

Where:

$\sigma_k$	Characteristic density of the timber in kg/m <sup>3</sup>
------------	-----------------------------------------------------------

The shape of the nail directly under the head shall be in the form of a truncated cone with a diameter under the nail head which exceeds the hole diameter.

The design models allow the use of fasteners described in the table on page 9 in Annex A

No performance has been determined in relation to ductility of a joint under cyclic testing. The contribution to the performance of structures in seismic zones, therefore, has not been assessed.

No performance has been determined in relation to the joint's stiffness properties - to be used for the analysis of the serviceability limit state.

#### 3.11 Aspects related to the performance of the product

Corrosion protection in service class 1 and 2.

In accordance with ETAG 015 the angle brackets are made from pre-galvanized steel DX 51 D / Z 275 according to EN 10346:2009 with  $R_e \geq 295$  N/mm<sup>2</sup>,  $R_m \leq 360$  N/mm<sup>2</sup> and  $A_{80} \geq 22\%$

#### 3.12 General aspects related to the use of the product

Drüeke & Springob angle brackets are manufactured in accordance with the provisions of this European Technical Assessment using the manufacturing processes as identified in the inspection of the plant by the notified inspection body and laid down in the technical documentation

#### Drüeke & Springob angle brackets

The nailing pattern used shall be either the maximum or the minimum pattern as defined in Annex A.

The following provisions concerning installation apply:

The structural members – the components 1 and 2 shown in the figure on page 14 - to which the brackets are fixed shall be:

- Restrained against rotation. At a load  $F_4/F_5$ , the component 2 is allowed to be restrained against rotation by the Angle brackets.
- Strength class C14 or better, see section 1 of this ETA
- Free from wane under the bracket.
- The actual end bearing capacity of the timber member to be used in conjunction with the bracket is checked by the designer of the structure to ensure it is not less than the bracket capacity and, if necessary, the bracket capacity reduced accordingly.
- The gap between the timber members does not exceed 3 mm.
- There are no specific requirements relating to preparation of the timber members.

The execution of the connection shall be in accordance with the assessment holder's technical literature.

## **4 Assessment and verification of constancy of performance (AVCP)**

### **4.1 AVCP system**

According to the decision 97/638/EC of the European Commission<sup>1</sup>, as amended, the system(s) of assessment and verification of constancy of performance (see Annex V to Regulation (EU) No 305/2011) is 2+.

## **5 Technical details necessary for the implementation of the AVCP system, as foreseen in the applicable EAD**

Technical details necessary for the implementation of the AVCP system are laid down in the control plan deposited at ETA-Danmark

Issued in Copenhagen on 2015-10-15 by



Thomas Bruun  
Managing Director, ETA-Danmark

## Annex A Product details definitions

Table A.1 Materials specification

Bracket number	Bracket type	Thickness (mm)	Steel specification	Coating specification
1131	70x70x55	2,5	DX 51 D	Z 275
1111	70x70x55 with rib	2,5	DX 51 D	Z 275
1132	90x90x65	2,5	DX 51 D	Z 275
1112	90x90x65 with rib	2,5	DX 51 D	Z 275
1133	105x105x90	3,0	DX 51 D	Z 275
1113	105x105x90 with rib	3,0	DX 51 D	Z 275

Table A.2 Range of sizes

Bracket number	Bracket type	Height (mm)		Height (mm)		Width (mm)	
		vertical	vertical	horizontal	horizontal		
1131	70x70x55	69	71	69	71	54	56
1111	70x70x55 with rib	69	71	69	71	51,5	56
1132	90x90x65	89	91	89	91	64	66
1112	90x90x65 with rib	89	91	89	91	59	66
1133	105x105x90	104	106	104	106	89	91
1113	105x105x90 with rib	104	106	104	106	83	91

Table A.3 Fastener specification

Nail type	Nail size (mm)		Finish
	Diameter	Length	
According to EN 14592			
Threaded nail	4,0	40	Electroplated zinc

In the load-carrying-capacities of the nailed connection in Annex B the capacities for threaded nails calculated from the formulas of Eurocode 5 are used assuming a thick steel plate when calculating the lateral nail load-carrying-capacity.

The load-carrying-capacities of the angle brackets have been determined based on the use of connector nails 4,0 x 40 mm in accordance with the German national approval for the nails.

The characteristic withdrawal capacity of the nails has to be determined by calculation in accordance with EN 1995-1-1:2004, paragraph 8.3.2 (head pull-through is not relevant):

$$F_{ax,Rk} = f_{ax,k} \times d \times t_{pen}$$

Where:

$f_{ax,k}$  Characteristic value of the withdrawal parameter in N/mm<sup>2</sup>

$d$  Nail diameter in mm

$t_{pen}$  Penetration depth of the profiled shank including the nail point in mm,  $t_{pen} \geq 31$  mm

Based on tests by Versuchsanstalt für Stahl, Holz und Steine, University of Karlsruhe, the characteristic value of the withdrawal resistance for the threaded nails used can be calculated as:

$$f_{ax,k} = 50 \times 10^{-6} \times \rho_k^2$$

Where:

$\rho_k$  Characteristic density of the timber in kg/m<sup>3</sup>

The shape of the nail directly under the head shall be in the form of a truncated cone with a diameter under the nail head which exceeds the hole diameter.



**Drüeke & Springob Angle Brackets**

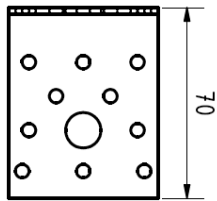
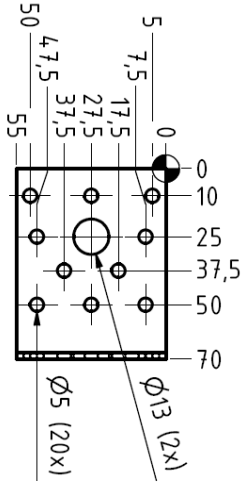

Figure A. 1 Dimensions of Angle Bracket 1131

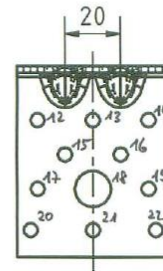
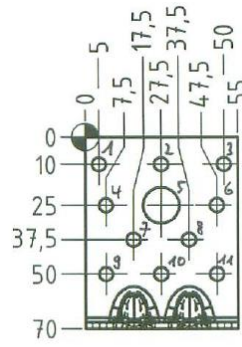

Figure A. 2 Dimensions of Angle Bracket 1111

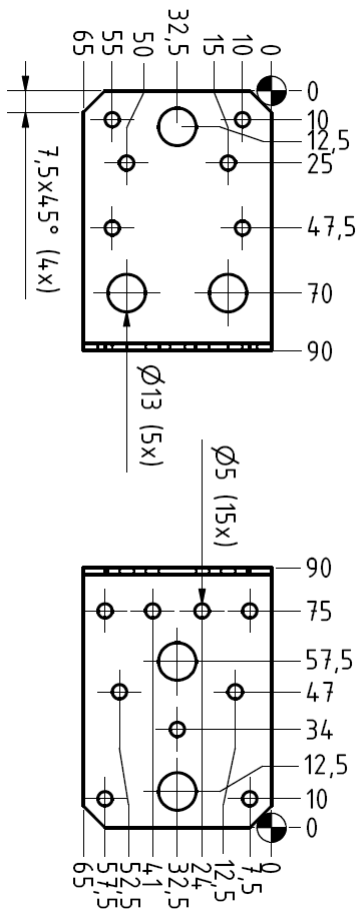

Figure A. 3 Dimensions of Angle Bracket 1132

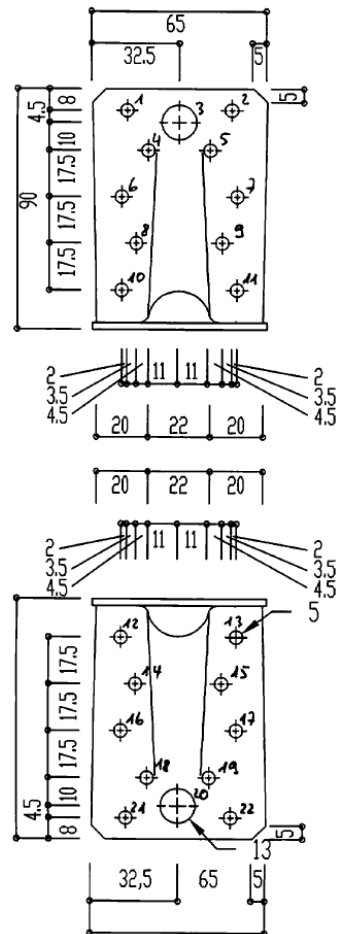

Figure A. 4 Dimensions of Angle Bracket 1112

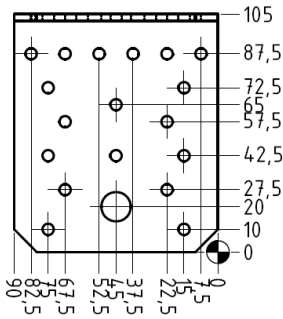
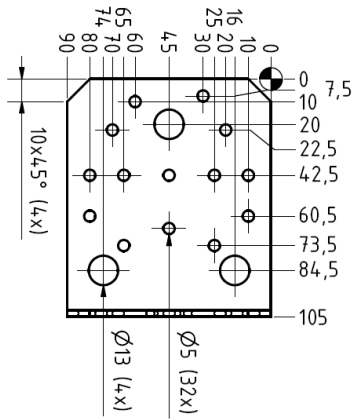

Figure A. 5 Dimensions of Angle Bracket 1133

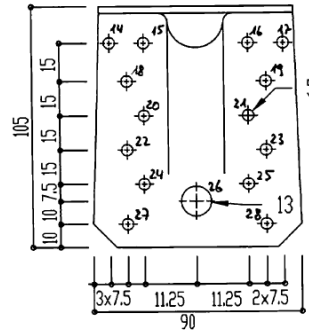
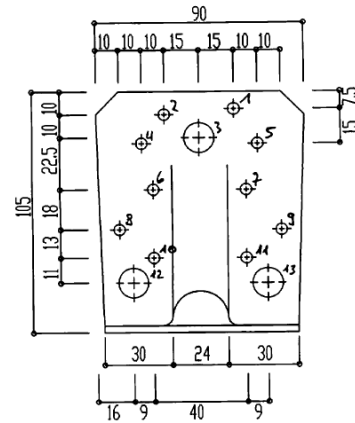

Figure A. 6 Dimensions of Angle Bracket 1113

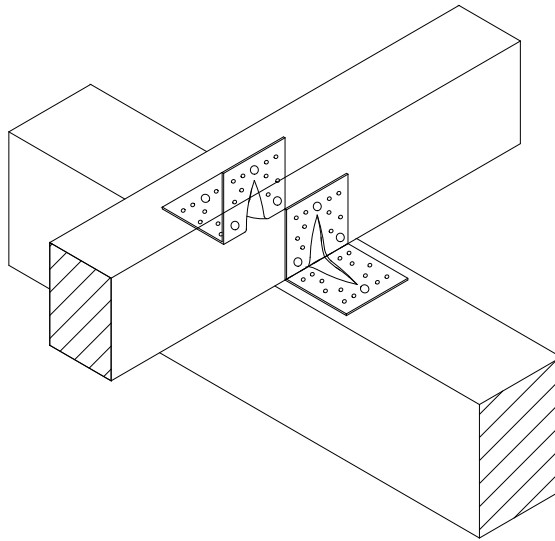

Figure A. 7 Typical installation

**Nail Patterns – Angle Bracket 1131**

**LC 1 – column**

Nails in hole number:

1,2,3 /

12,13,14,15,16,20,21,22

Art. Nr.: 1131  
70x70x55x2,5

LF1

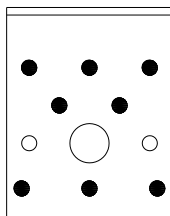
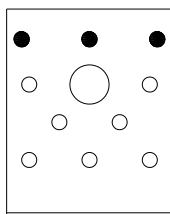

**LC 1 – purlin, LC 2/3, LC 4/5**

Nails in hole number:

1,2,3,7,8 /

12,13,14,15,16,20,21,22

LF2

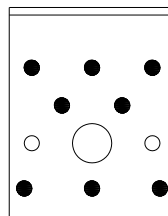
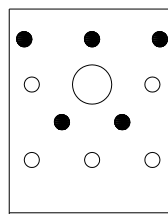

**Nail Patterns – Angle Bracket 1111 with rib**

**LC 1 – column**

Nails in hole number:

1,2,3 /

12,13,14,15,16,20,21,22

Art. Nr.: 1111  
70x70x55x2,5 with Rib

LF1

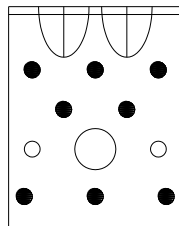
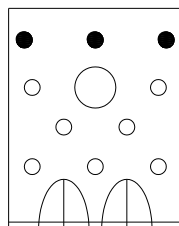

**LC 1 – purlin, LC 2/3, LC 4/5**

Nails in hole number:

1,2,3,7,8 /

12,13,14,15,16,20,21,22

LF2

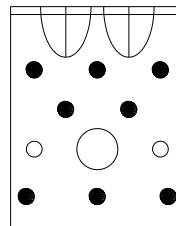
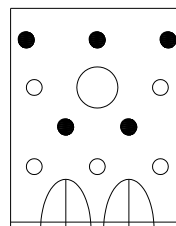

**Nail Patterns – Angle Bracket 1132**

**LC 1 – column**

Nails in hole number:

1,2 /

10,11,12,13,15,16,17,19,20,

Art. Nr.: 1132  
90x90x65x2,5

LF1

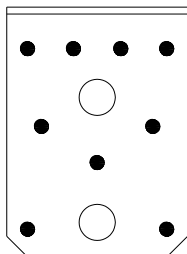
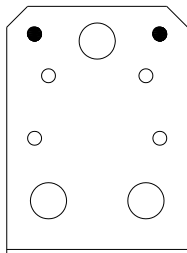

**LC 1 – purlin, LC 2/3, LC 4/5**

Nails in hole number:

1,2,4,5,6,7 /

10,11,12,13,15,16,17,19,20

LF2

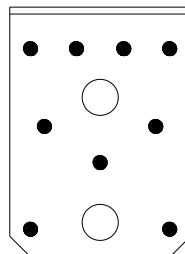
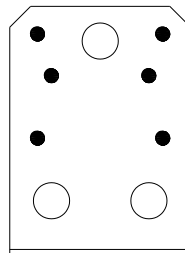

**Nail Patterns – Angle Bracket 1112 with rib**

**LC 1 – column**

Nails in hole number:

1,2 /

12,13,16,17,21,22

Art. Nr.: 1112  
90x90x65x2,5 with Rib

LF1

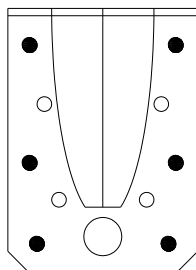
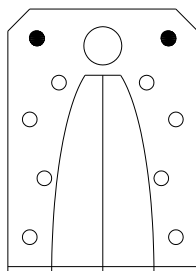

**LC 1 – purlin, LC 2/3, LC 4/5**

Nails in hole number:

1,2,4,6,7,8,9 /

12,13,16,17,21,22

LF2

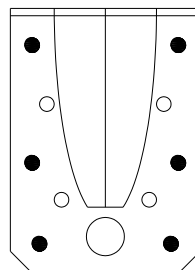
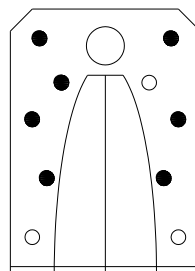

**Nail Patterns – Angle Bracket 1133**

**LC 1 – column**

Nails in hole number:

1,2,4,5,6,8,10 /

18,19,20,21,22,23,26,27,28,30,35,36

Art. Nr.: 1133  
105x105x90x3,0  
LF1

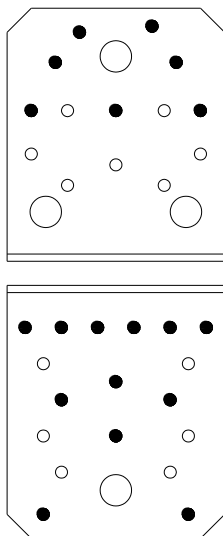

**LC 1 – purlin, LC 2/3, LC 4/5**

Nails in hole number:

1,2,4,5,6,8,10,11,12,14,15 /

18,19,20,21,22,23,26,27,28,30,35,36

LF2

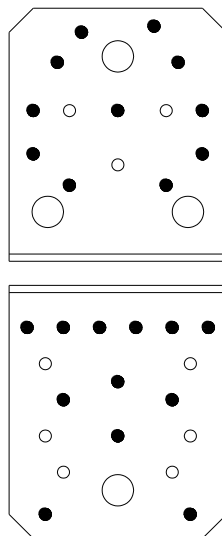

**Nail Patterns – Angle Bracket 1113 with rib**

**LC 1 – column**

Nails in hole number:

1,2,4,5,6,7 /

14,15,16,17,20,21, 27,28

Art. Nr.: 1113  
105x105x90x3,0 with Rib  
LF1

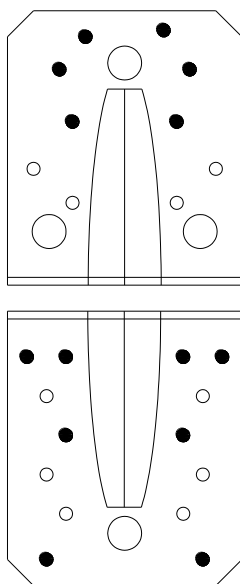

**LC 1 – purlin, LC 2/3, LC 4/5**

Nails in hole number:

1,2,4,5,6,7,8,9,10,11 /

14,15,16,17,20,21, 27,28

LF2

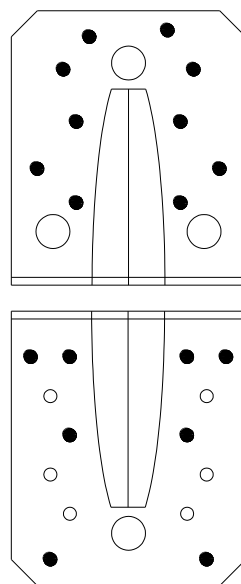

## Annex B Characteristic load-carrying capacities

### Definitions of forces, their directions and eccentricity

#### Forces - Beam to beam connection

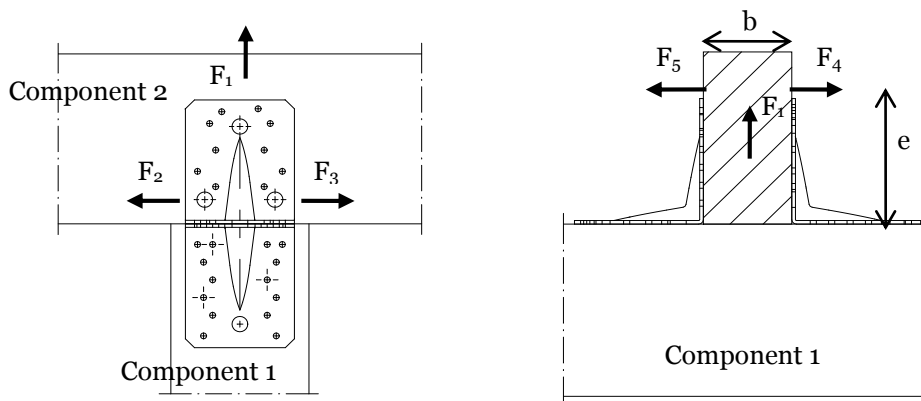

#### Fastener specification

Holes are marked with numbers referring to the nailing pattern in Annex A.

#### Double angle brackets per connection

The angle brackets must be placed at each side opposite to each other, symmetrically to the component axis.

#### Acting forces

- $F_1$                       Lifting force acting along the central axis of the joint.
- $F_2$  and  $F_3$             Lateral force acting in the joint between the component 2 and component 1 in the component 2 direction
- $F_4$  and  $F_5$             Lateral force acting in the component 1 direction along the central axis of the joint. If the load is applied with an eccentricity  $e$ , a design for combined loading is required.

#### Single angle bracket per connection

#### Acting forces

- $F_1$                       Lifting force acting in the central axis of the angle bracket. The component 2 shall be prevented from rotation. If the component 2 is prevented from rotation the load-carrying capacity will be half of a connection with double angle brackets.
- $F_2$  and  $F_3$             Lateral force acting in the joint between the component 2 and the component 1 in the component 2 direction. The component 2 shall be prevented from rotation. If the component 2 is prevented from rotation the load-carrying capacity will be half of a connection with double angle brackets.
- $F_4$  and  $F_5$             Lateral force acting in the component 1 direction in the height of the top edge of component 2. The component 2 shall be prevented from rotation.  $F_4$  is the lateral force towards the angle bracket;  $F_5$  is the lateral force away from the angle bracket. Only the characteristic load-carrying capacities for angle brackets with ribs are given.

#### Wane

Wane is not allowed, the timber has to be sharp-edged in the area of the angle brackets.

#### Timber splitting

For the lifting force  $F_1$  it must be checked in accordance with Eurocode 5 or a similar national Timber Code that splitting will not occur.

#### Combined forces

If the forces  $F_1$  and  $F_2/F_3$  or  $F_4/F_5$  act at the same time, the following inequality shall be fulfilled:

$$\left(\frac{F_{1,d}}{F_{Rd,1}}\right)^2 + \left(\frac{F_{2,d}}{F_{Rd,2}}\right)^2 + \left(\frac{F_{3,d}}{F_{Rd,3}}\right)^2 + \left(\frac{F_{4,d}}{F_{Rd,4}}\right)^2 + \left(\frac{F_{5,d}}{F_{Rd,5}}\right)^2 \leq 1$$

The forces  $F_2$  and  $F_3$  or  $F_4$  and  $F_5$  are forces with opposite direction. Therefore only one force  $F_2$  or  $F_3$ , and  $F_4$  or  $F_5$ , respectively, is able to act simultaneously with  $F_1$ , while the other shall be set to zero.

If the load  $F_4/F_5$  is applied with an eccentricity  $e$ , a design for combined loading **for connections with double angle brackets** is required. Here, an additional force  $\Delta F_1$  has to be added to the existing force  $F_1$ .

$$\Delta F_{1,d} = F_{4,d} / F_{5,d} \cdot \frac{e}{B}$$

$B$  is the width of component 2.

**Table B.1:** Force  $F_1$  Column, 2 angle brackets / connection

Bracket number	Bracket type	Nail number $n_v$	Nail number $n_H$	$F_{1,Rk}$ [kN] (column)	
				Timber	Steel
1131	70x70x55	1,2,3	12,13,14,15,16,20,21,22	3,15	1,84
1111	70x70x55 with rib	1,2,3	12,13,14,15,16,20,21,22	3,15	1,84
1132	90x90x65	1,2	10,11,12,13,15,16,17,19,20	5,00	2,77
1112	90x90x65 with rib	1,2	12,13,16,17,21,22	2,50	6,31
1133	105x105x90	1,2,4,5,6,8,10	18,19,20,21,22,23,26,27,28, 30,35,36	7,52	4,55
1113	105x105x90 with rib	1,2,4,5,6,7	14,15,16,17,20,21,27,28	5,01	15,8

**Table B.2:** Force  $F_1$  Column, 1 angle bracket / connection

Bracket number	Bracket type	Nail number $n_v$	Nail number $n_H$	$F_{1,Rk}$ [kN] (column)	
				Timber	Steel
1131	70x70x55	1,2,3	12,13,14,15,16,20,21,22	1,58	0,92
1111	70x70x55 with rib	1,2,3	12,13,14,15,16,20,21,22	1,58	0,92
1132	90x90x65	1,2	10,11,12,13,15,16,17,19,20	2,50	1,38
1112	90x90x65 with rib	1,2	12,13,16,17,21,22	1,25	3,15
1133	105x105x90	1,2,4,5,6,8,10	18,19,20,21,22,23,26,27,28, 30,35,36	3,76	2,28
1113	105x105x90 with rib	1,2,4,5,6,7	14,15,16,17,20,21,27,28	2,51	7,91

**Table B.3:** Force  $F_1$  Purlin, 2 angle brackets / connection

Bracket number	Bracket type	Nail number $n_v$	Nail number $n_H$	$F_{1,Rk}$ [kN] (purlin)	
				Timber	Steel
1131	70x70x55	1,2,3,7,8	12,13,14,15,16,20,21,22	3,15	1,84
1111	70x70x55 with rib	1,2,3,7,8	12,13,14,15,16,20,21,22	3,15	1,84
1132	90x90x65	1,2,4,5,6,7	10,11,12,13,15,16,17,19,20	5,00	2,77
1112	90x90x65 with rib	1,2,4,6,7,8,9	12,13,16,17,21,22	2,50	6,31
1133	105x105x90	1,2,4,5,6,8,10, 11,12,14,15	18,19,20,21,22,23,26,27,28,30, 35,36	7,52	4,55
1113	105x105x90 with rib	1,2,4,5,6,7,8, 9,10,11	14,15,16,17,20,21,27,28	5,01	15,8



**Table B.4:** Force  $F_1$  Purlin, 1 angle bracket / connection

Bracket number	Bracket type	Nail number $n_V$	Nail number $n_H$	$F_{1,Rk}$ [kN] (purlin)	
				Timber	Steel
1131	70x70x55	1,2,3,7,8	12,13,14,15,16,20,21,22	1,58	0,92
1111	70x70x55 with rib	1,2,3,7,8	12,13,14,15,16,20,21,22	1,58	0,92
1132	90x90x65	1,2,4,5,6,7	10,11,12,13,15,16,17,19,20	2,50	1,38
1112	90x90x65 with rib	1,2,4,6,7,8,9	12,13,16,17,21,22	1,25	3,15
1133	105x105x90	1,2,4,5,6,8,10, 11,12,14,15	18,19,20,21,22,23,26,27, 28,30,35,36	3,76	2,28
1113	105x105x90 with rib	1,2,4,5,6,7,8, 9,10,11	14,15,16,17,20,21,27,28	2,51	7,91

**Table B.5:** Forces  $F_{2,3}$ , 2 angle brackets / connection

Bracket number	Bracket type	Nail number $n_V$	Nail number $n_H$	$F_{2,3,Rk}$ [kN]
				Timber
1131	70x70x55	1,2,3,7,8	12,13,14,15,16,20,21,22	5,80
1111	70x70x55 with rib	1,2,3,7,8	12,13,14,15,16,20,21,22	5,80
1132	90x90x65	1,2,4,5,6,7	10,11,12,13,15,16,17,19,20	7,34
1112	90x90x65 with rib	1,2,4,6,7,8,9	12,13,16,17,21,22	7,06
1133	105x105x90	1,2,4,5,6,8,10, 11,12,14,15	18,19,20,21,22,23,26,27,28,30,35,36	11,9
1113	105x105x90 with rib	1,2,4,5,6,7,8, 9,10,11	14,15,16,17,20,21,27,28	10,1

**Table B.6:** Forces  $F_{2,3}$ , 1 angle bracket / connection

Bracket number	Bracket type	Nail number $n_V$	Nail number $n_H$	$F_{2,3,Rk}$ [kN]
				Timber
1131	70x70x55	1,2,3,7,8	12,13,14,15,16,20,21,22	2,90
1111	70x70x55 with rib	1,2,3,7,8	12,13,14,15,16,20,21,22	2,90
1132	90x90x65	1,2,4,5,6,7	10,11,12,13,15,16,17,19,20	3,67
1112	90x90x65 with rib	1,2,4,6,7,8,9	12,13,16,17,21,22	3,53
1133	105x105x90	1,2,4,5,6,8,10, 11,12,14,15	18,19,20,21,22,23,26,27,28,30,35,36	5,94
1113	105x105x90 with rib	1,2,4,5,6,7,8, 9,10,11	14,15,16,17,20,21,27,28	5,06

**Table B.7:** Basic Forces  $F_{4,5}$ , 2 angle brackets / connection

Bracket number	Bracket type	Nail number $n_V$	Nail number $n_H$	$F_{4,5,Rk}$ [kN]	
				Timber	Steel
1131	70x70x55	1,2,3,7,8	12,13,14,15,16,20,21,22	5,34	4,34
1111	70x70x55 with rib	1,2,3,7,8	12,13,14,15,16,20,21,22	5,85	4,02
1132	90x90x65	1,2,4,5,6,7	10,11,12,13,15,16,17,19,20	7,82	4,45
1112	90x90x65 with rib	1,2,4,6,7,8,9	12,13,16,17,21,22	7,03	4,17
1133	105x105x90	1,2,4,5,6,8,10, 11,12,14,15	18,19,20,21,22,23,26,27,28,30, 35,36	9,30	8,46
1113	105x105x90 with rib	1,2,4,5,6,7,8, 9,10,11	14,15,16,17,20,21,27,28	9,96	13,1

**Table B.8:** Basic Forces  $F_4$ , 1 angle bracket / connection

Bracket number	Bracket type	Nail number $n_V$	Nail number $n_H$	$F_{4,Rk}$ [kN]	
				Timber	Steel
1111	70x70x55 with rib	1,2,3,7,8	12,13,14,15,16,20,21,22	5,85	3,08
1112	90x90x65 with rib	1,2,4,6,7,8,9	12,13,16,17,21,22	7,03	3,66
1113	105x105x90 with rib	1,2,4,5,6,7,8, 9,10,11	14,15,16,17,20,21,27,28	9,96	9,21

**Table B.9:** Basic Forces  $F_5$ , 1 angle bracket / connection

Bracket number	Bracket type	Nail number $n_V$	Nail number $n_H$	$F_{5,Rk}$ [kN]	
				Timber	Steel
1111	70x70x55 with rib	1,2,3,7,8	12,13,14,15,16,20,21,22	1,38	1,19
1112	90x90x65 with rib	1,2,4,6,7,8,9	12,13,16,17,21,22	1,98	1,17
1113	105x105x90 with rib	1,2,4,5,6,7,8, 9,10,11	14,15,16,17,20,21,27,28	2,95	4,82